

30A DC brushed motor PWM speed controller

DATASHEET FOR: Motor PWM BR10050 1.1F (200V)

TECHNICAL SPECIFICATIONS:

Supply voltage:	22-200V
Output current:	45A peak 30A continuous at 25°C PCB version needs additional heatsink!
Minimal duty cycle:	0%
Maximal duty cycle:	97%
Protections:	Over current protection, Output short protection with minimal load inductance
Switching frequency:	20kHz
Power connection:	M6
Dimensions:	90 x 95 x 33 mm
Weight:	180g

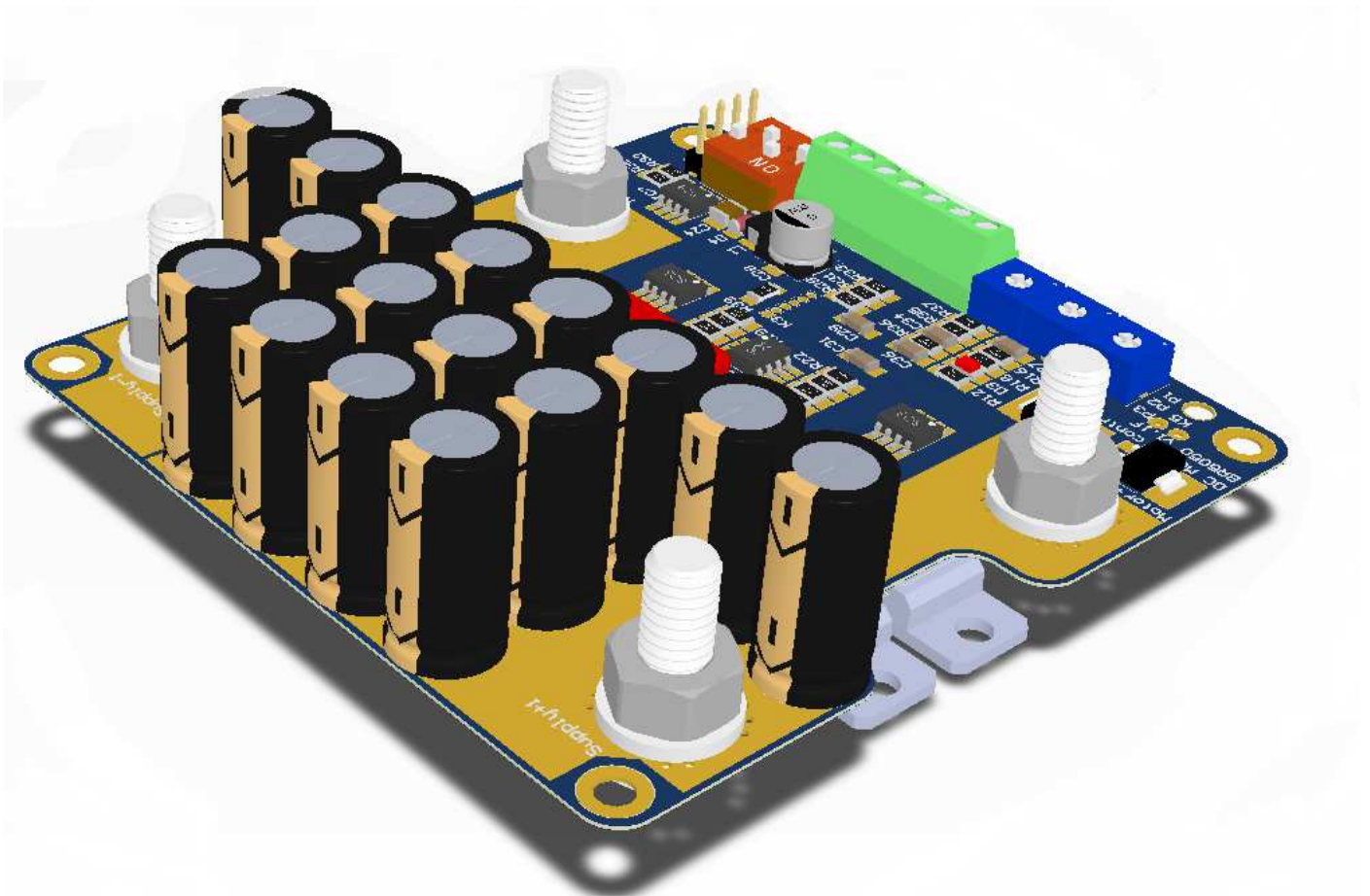

PIN DESCRIPTION:

Motor+: The motor negative connection.

Motor-: The motor positive connection.

Supply+: The positive power supply connection 22-200V maximal voltage.

Supply-: The negative supply connection.

Speed GND: Ground for the speed potentiometer. Keep it isolated from the Supply GND.

Speed:

Speed potentiometer input. Use 1-10 kOhm linear potentiometer or 0-5V controll voltage.

- Potentiometer mode: 0V = 0% duty cycle
4,95V = 97% duty cycle
- Throttle mode: 0.8V = 0% duty cycle
4,2V = 97% duty cycle
- *USART mode: Analoge input.

+5V: +5V reference voltage for the speed potentiometer and for small external circuits. Max load current 50mA.

Brake/PWM input:

- Potentiometer or throttle mode: brake switch input.
- PWM mode1: 0-100% PWM: You can use your own PWM controll signal from your PLC or microprocessor. The minimum controll PWM frequency is 100Hz. The step resolution 1us. The acceptable voltage level: 3,3-10V.
- PWM mode2: RC wirelles receiver input 1,5msec pulse for the 0% duty cycle and 2,5msec pulse for the 97% duty cycle.
- PWM, logical and pulse counter input in USART mode

Mode switch:

1OFF-2OFF: Hall throtle mode

1OFF-2ON: Potentiometer mode

1ON-2OFF: PWM input mode

1ON-2ON: RC-receiver PWM mode

3OFF: Peak current OFF 3ON: Peak current OFF

4ON: RS232 UART simple command mode communication

4OFF: RS232 USART advanced mode

Controll potentiometers:

P1: Curren limit potentiometer 0-30A (if the current limit is zero the motor won't start)

P2: Acceleration limit potentiometer 0-41sec

P3: Regenerative current limit potentiometer with zero setting no regenerativa brake.

LED light on when:

-output current limitation is active.

-over voltage protection, over temperature protection

-while USART communication.

Instructions for the heatsink:

The PCB version of the controller needs an additional heatsink or aluminium case to cool the power transistors. The dimensions of the heatsink can change depending on the supply voltage and the output current and of course the ambient temperature and the convection. Normally use a 100mmx100mmx25mm (4"x4"x 1") aluminium heatsink or equivalent aluminium case.

Heat sensor: The controller also has a heat sensor with 15cm cable. Fix this sensor to the heatsink as well just like the power transistors. But it is not important to isolate this sensor.

Step by step:

1. In the right positions drill M3 holes for the power transistors and for the fastening screws.
2. The hole's edges needs to be clear and burr free (small burr under the transistors can harm and penetrate the isolators causing short between the transistors and the heatsink).
3. Place heat conductor paste (6) under the isolator. Quantity is not important it need to be only a thin layer.
4. Place the silicone isolators in place. (1)
5. Make sure all the transistors flags are parallel with the heatsink. Having gap under the transistors flags can cause bad thermal contact overheating and damage.
5. Place the board and the transistors on the heatsink and fix it with the screws (5). Use the small white plastic isolator rings (2) under the screws to avoid the short between the metal flags and the screws.
6. Make sure all the screws are tight enough to have the best thermal contact.
7. Check the isolation between the transistors flags and the heatsink with digital ohm meter

Fixing from down side:

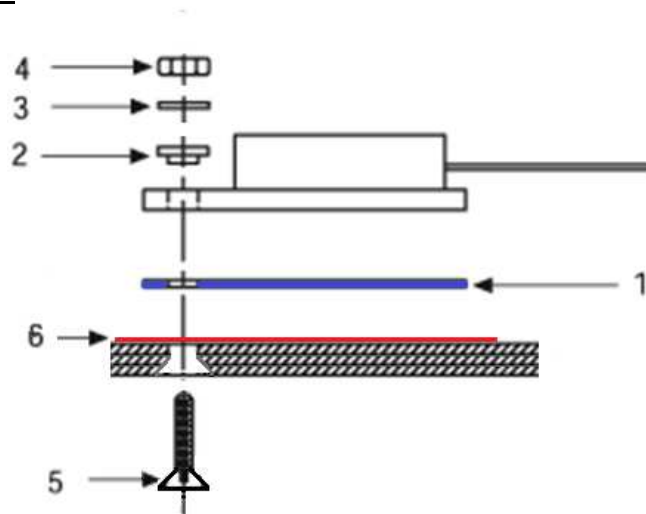

Fixing from up side:

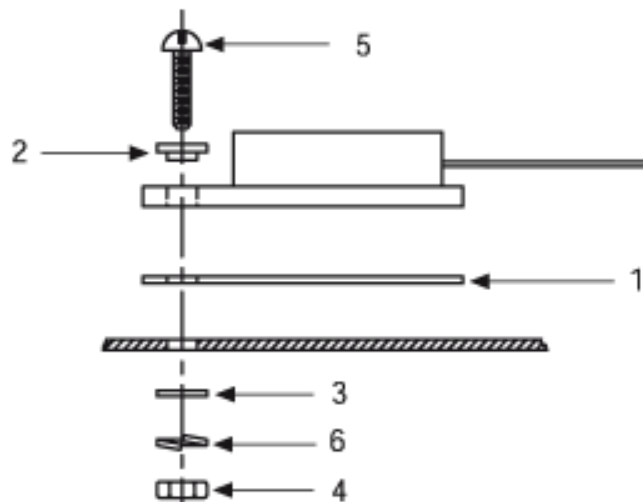

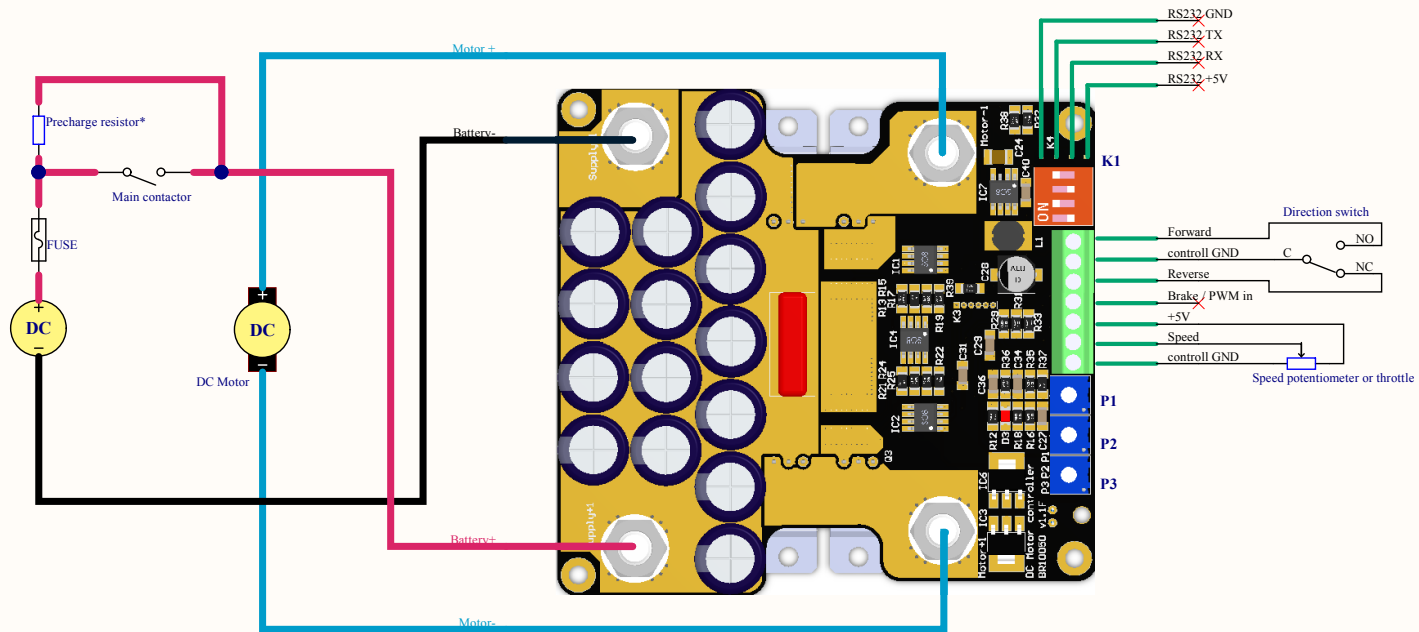

Title		
Standard potentiometer or throttle		
Size	Number	Revision
A3	FR10050	Rev1
Date:	2018.04.05.	Sheet of
File:	E:\Projekte\k1\Wir1.SchDoc	Drawn By:

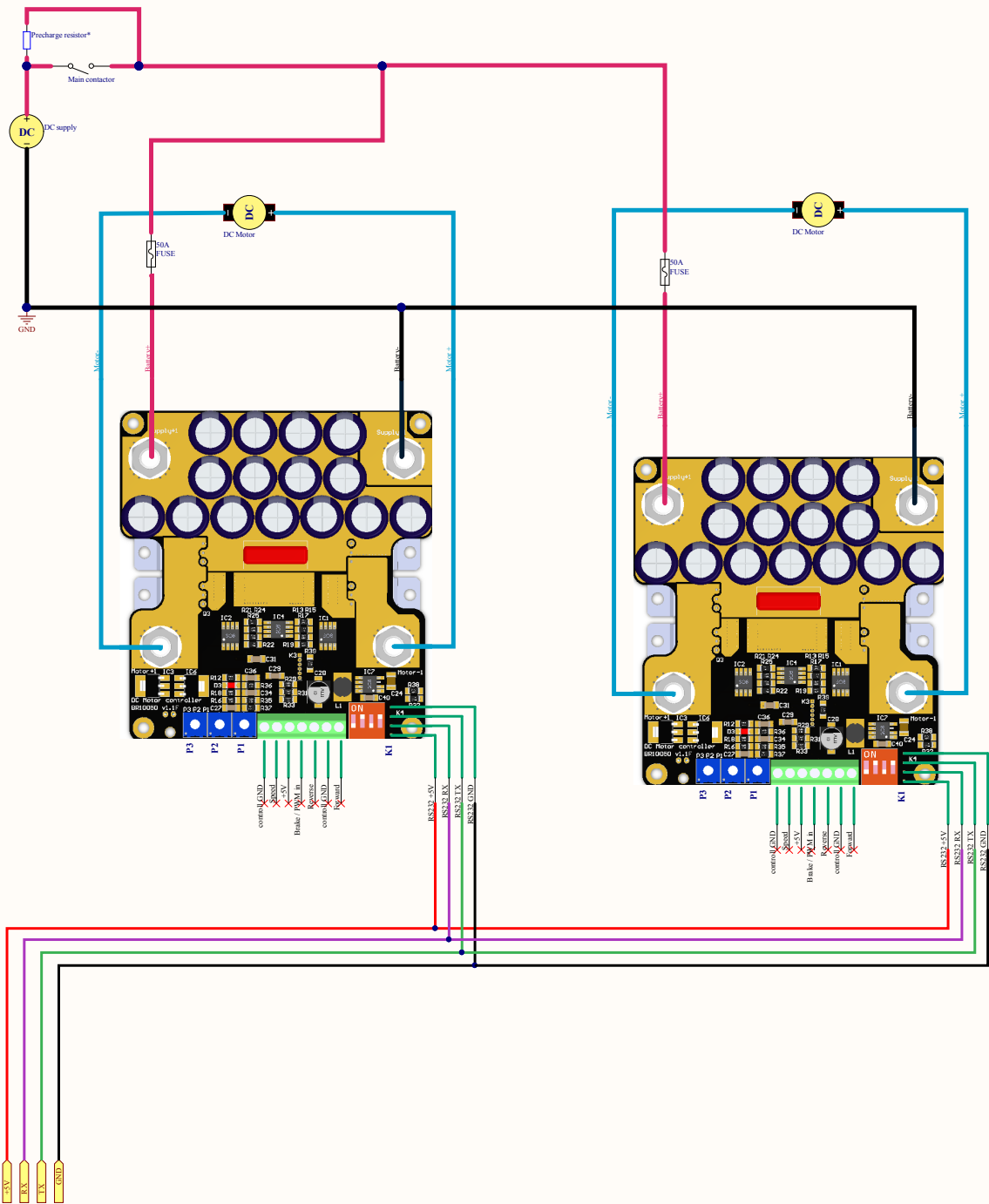

Title			
Connecting several units on one RS232 line			
Size	Number		Revision
A2	BR10050		Rev1
Date:	2018.04.05	Sheet of	
File:	F:\Projekte3\Wirz_SchDec	Drawn By:	

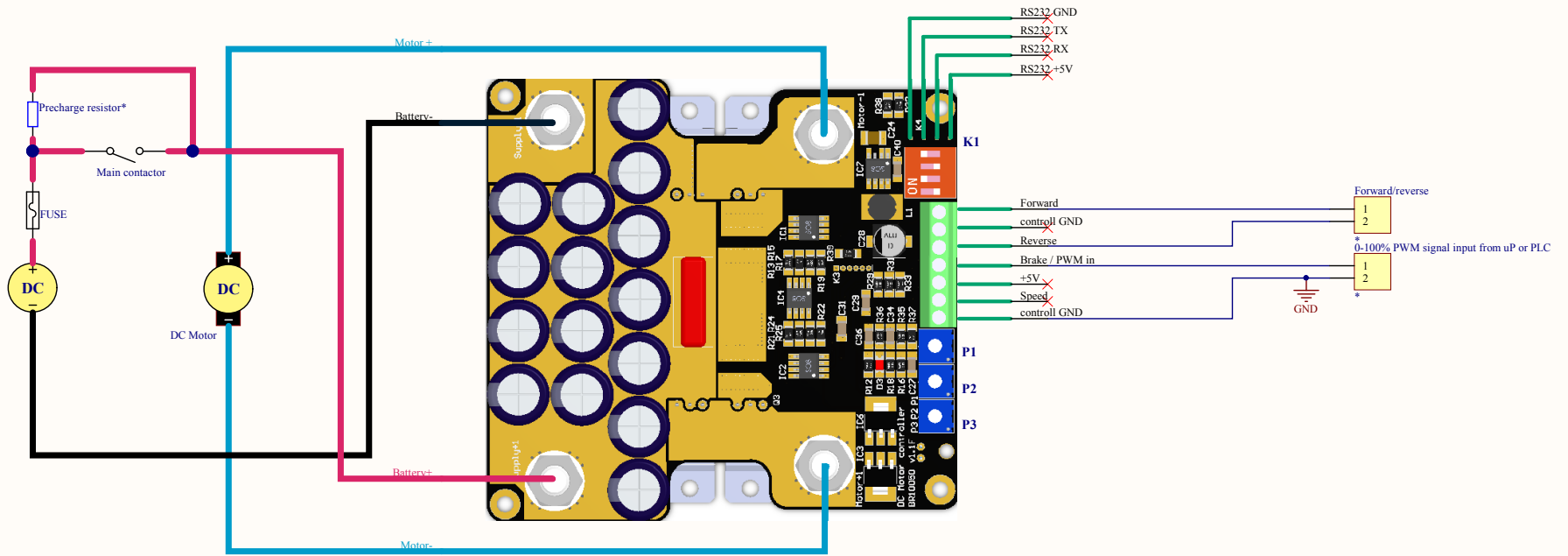

Title			PWM input control		
Size	Number	Revision			
A3	FR5050	Rev1			
Date:	2018.04.05.	Sheet of			
File:	E:\Projekte\k\Wir3.SchDoc	Drawn By:			

Controll register map for simple UART communication:

UART Data transmission:

revision: 1. *UART firmware v1.0*

Supported default baud rate: 9600 baud/sec

Supported bit rate: 1 start 8 data bit 1 stop and no parity bit.

Writing register you need to send first the comand byte than the second the data byte which contains the value of the writen register. Reading a register send the request command and wait for the data from the controller.

Sent bytes

Command	Data	Write registers:	remark:
0x80	0x00-7F	speed motor 1	
0x82	0x00-7F	current limit	0,23A/lb
0x83	0x00-7F	regen limit	0,23A/lb
0x84	0x00-7F	accel limit	0,32ms/lb
0x85	0x00-7F	decel limit	0,32ms/lb
0x86	0x00-7F	turn off low	2,14V/lb
0x87	0x00-7F	turn on low	2,14V/lb
0x88	0x00-7F	turn on high	2,14V/lb
0x89	0x00-7F	turn off high	2,14V/lb
0x8A	0x00-03	motor deirection	0x00: stop, 0x01 forward, 0x02: reverse, 0x03 regen
0xE0	-	USART command mode	Autostop after 3 sec without speed update
0xE1	-	USART command mode	No Autostop
0xE2	-	cancel USART mode	Controll with onboard potentiometers
0xA0	0x00-7F	saving_bits L	for saving use advanced mode
0xA1	0x00-7F	saving_bits H	for saving use advanced mode

Command	Read registers:		
0xC0	00-7F	read motor 1 speed	
0xC2	00-7F	read current limit	0,23A/lb
0xC3	00-7F	read regen limit	0,23A/lb
0xC4	00-7F	read accel limit	0,32ms/lb
0xC5	00-7F	read decel limit	0,32ms/lb
0xC6	00-7F	read turn off low	2,14V/lb
0xC7	00-7F	read turn on low	2,14V/lb
0xC8	00-7F	read turn on high	2,14V/lb
0xC9	00-7F	read turn off high	2,14V/lb
0xCA	00-7F	motor 1 current	0,471A/lb
0xCC	00-7F	suppyl voltage	2,14V/lb
0xCD	00-7F	speed input	37,7mV=lb
0xCE		heatsink_temp	1C
0xCF		mainboard_temp	1C
0xD0		status bits L	

0xD1	status bits H
0xD2	configurations_bits_1 L
0xD3	configurations_bits_1 H
0xD4	configurations_bits_2 L
0xD5	configurations_bits_2 H
0xDE	software version
0xDF	hardware version

If you need more details about what the status register and confoguration_bits are doing please check the advanced communication.

Examples:

1, Start the controller in uart control mode:

Send 0xE0 or 0xE1 (with E0 you need to send a new speed data in every 3 sec otherwise the controller will stop the motor)

2, Select direction forward:

Send 0x8A 0x01

3, Speed up the motor slowly:

Acceleration set: **Send 0x84 0x0F**

Speed set: **Send 0x80 0x1F**

4, Set lower 50% speed:

Send 0x80 0x3F

5, Read motor current:

Send 0xCA

6, Read supply voltage:

Send 0xCC

7, Select direction reverse:

Send 0x8A 0x02

UART Data transmission:

revision: 1. UART firmware v1.0

Supported default baud rate: 19200 baud/sec

Supported bit rate: 1 start 8 data bit 1 stop and no parity bit.

Sending data:

The controllers are working in SLAVE mode UART communication. It means that every commands are addressable and only the controller which has the same address will accept the command otherwise it goes into stanby mode. When an address match occurs the the controller wakes up and accept the data. As long as the controller does not get other address which is not its own address remains in active mode.

Sending data from master device must be 5 bytes:

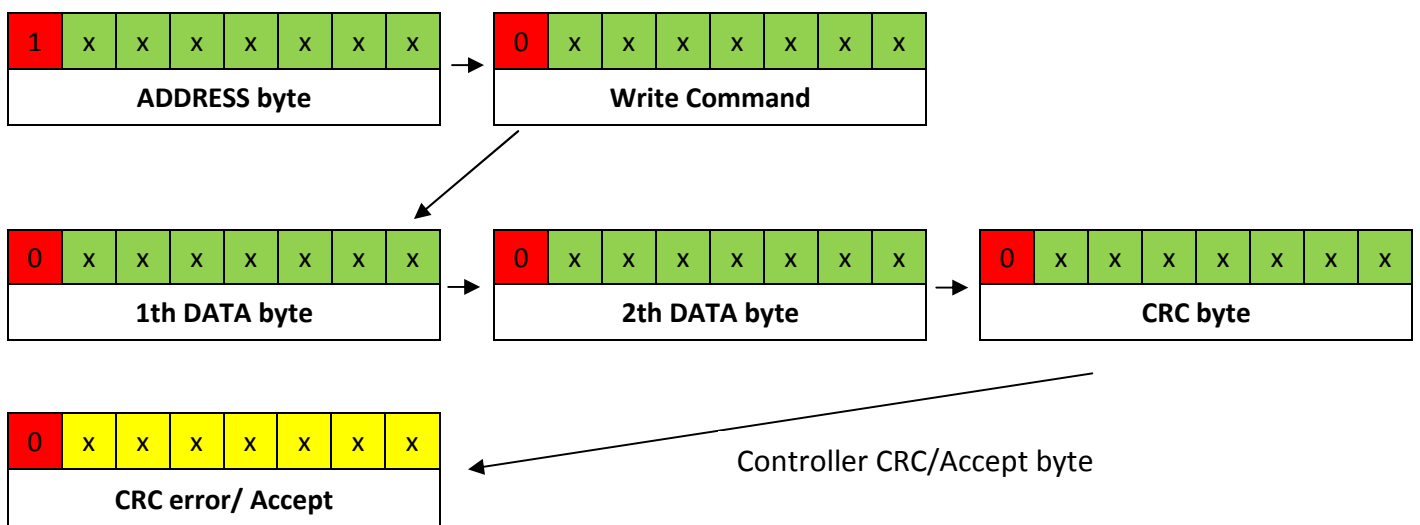

Every ADDRESS byte MSB bit must be "1" any other which is not an ADDRESS byte must be "0".

For robust and errorless communication CRC byte can be used to check the data transmission errors.

CRC ckeck byte calculated: ((Write command byte + 1th DATA byte + 2th DATA byte) & 0x7F)

Receiving successfully the write command and the DATA bytes the controller send a confirmation byte with his UART address (0x00 | address) or CRC error message with his address (0x80 | address).You can use this byte to know when to send the next data.

Reading data:

Requesting data from master device must be 2 bytes when the controller received the 2th byte it will send the answer 3 bytes (1th DATA byte ; 2th DATA byte ; CRC)

CRC ckeck byte calculated: ((Read command byte + 1th DATA byte + 2th DATA byte) & 0x7F)

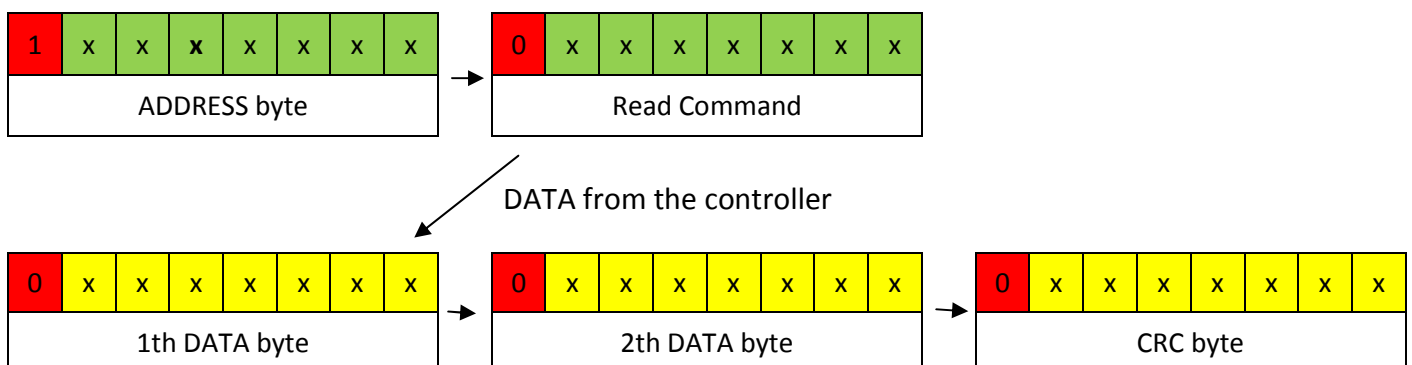

Control register map for advanced USART communication:

Model: BR10050 1.1F (200V)

Register name	Command		Min Val.	Max val.	Value Range	Resolution	Remark
	Read	Write					
speed motor 1	0x00	0x40	0x0000	0x0FFF	97% duty		Other factors may change the output duty
current limit	0x02	0x42	0x0000	0x0FFF	30.1A	7.36mA	This value is internally limited az 30A.
regen limit	0x03	0x43	0x0000	0x0FFF	30.1A	7.36mA	This value is internally limited at 30A.
accel limit	0x04	0x44	0x0000	0x0FFF	41 sec	10msec	
decel limit	0x05	0x45	0x0000	0x0FFF	41 sec	10msec	
turn off low	0x06	0x46	0x0000	0x0FFF	273.8V	66,88mV	
turn on low	0x07	0x47	0x0000	0x0FFF	273.8V	66,88mV	
turn on high	0x08	0x48	0x0000	0x0FFF	273.8V	66,88mV	Defaul value: 2600
turn off high	0x09	0x49	0x0000	0x0FFF	273.8V	66,88mV	Internally limited on 2701 (49,9V)
Heatsink Temperature	0x0A		0x000A	0x0050	80°C	1°C	Shut down at 75°C
Mainboard Temperature	0x0B		0x000A	0x0050	80°C	1°C	
	0x0F						
Supply Voltage	0x10				273.8V	66,88mV	
Speed ADC Input	0x11				4.85V	1.18mV	
Load Current 1	0x12				60.3A	29.4mA	0A=0x07FF
Input Frequency Period Register	0x14						
Input Pulse Width	0x15						
	0x19						
I*R compensation gain	0x20	0x60	0x0000	0x0FFF			
top speed	0x21	0x61	0x0000	0x0FFF	273.8V	66,88mV	
potentiometer min	0x22	0x62	0x0000	0x0FFF	4.85V	1.18mV	
potentiometer max	0x23	0x63	0x0001	0x0FFF	4.85V	1.18mV	
	0x24						
Status Register	0x30						
Lock_level_2 Variables	0x31	0x71					
Save bites 1	0x32	0x72					
save bites 2	0x33	0x73					
Configuration bits 1	0x34	0x74					
Configuration bits 2	0x35	0x75					
UART Address		0x7C	0x0000	0x007F			Default address 0x00
Current measurement calibration		0x7D	0x0000			29.4mA	
software version	0x3E						
hardware version	0x3F						

Speed Register:

Type: Write / Read

Write command: 0x40

Read command: 0x00

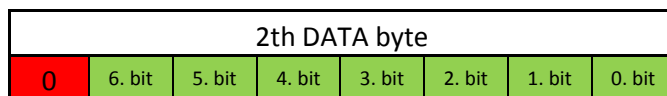
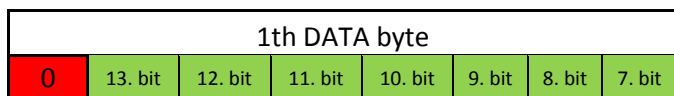

Speed register gives the base value of the output voltage (duty cycle). The final value depending some other factors. The final duty cycle depending on several other factors (current limits, regen modes..)

With default settings the speed register equal to the controller speed input ADC value modified by the acceleration/deceleration settings. Writing into this register this will be the new base value of the output voltage as long as the Speed input ADC has the same value as it was before the overwrite. When the Speed input voltage changes (turning up/down the speed potentiometer) the controller going to overwrite the register with the value of the potentiometer.

It is possible to lock the register value (speed potentiometer can't overwrite the speed register) for this feature use the **Lock Variable Register**.

The register set and cleared by UART write or Speed potentiometer input and loses it's value after restarting the controller. Saving the value into the FLASH use the **Save Register**.

Bit 11:0 **SPEED [11:0]**: Speed register value

Max value is 4095 it is the 97% duty cycle.

Min value is 0 it is the 0% duty cycle.

Note: final duty cycle may change depending on other factors.

Current Limit Register:

Type: Write / Read
 Write command: 0x42
 Read command: 0x02

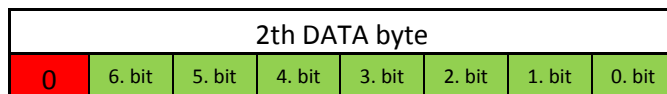
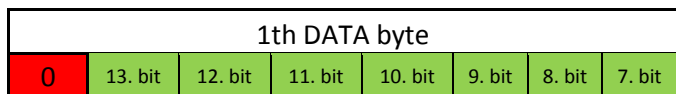

Current Limit Register sets the value of the current limitation. With default settings the current limit register is equal to the controller's current limit potentiometer setting. Writing into this register overwrites the value of the potentiometer and holds the value as long as the potentiometer has the same value as it was before the overwrite. When the potentiometer changes (turning up/down the potentiometer) the controller going to overwrite the register with the value of the potentiometer.

It is possible to lock the register value (potentiometer can't overwrite the register) for this feature use the **Lock Variable Register**.

The register set and cleared by UART write or the current limit potentiometer and loses it's value after restarting the controller. Saving the value into the FLASH use the **Save Register**.

Bit 11:0 **CURRENT_LIMIT [11:0]**: Current limit register value
Max value is 4095
Min value is 0

*Note: for the corresponding current value check the **Register Value Range** table.*

Regenerative Current Limit Register:

Type: Write / Read

Write command: 0x43

Read command: 0x03

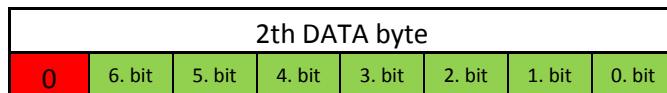
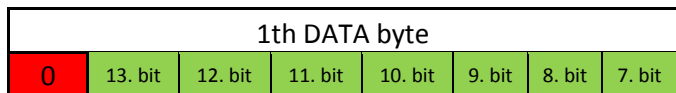

Regenerative Current Limit Register sets the value of the current limitation. With default settings the current limit register is equal to the controller's potentiometer setting. Writing into this register overwrites the value of the potentiometer and holds the value as long as the potentiometer has the same value as it was before the overwrite. When the potentiometer changes (turning up/down the potentiometer) the controller going to overwrite the register with the value of the potentiometer.

It is possible to lock the register value (potentiometer can't overwrite the register) for this feature use the **Lock Variable Register**.

The register set and cleared by UART write or the potentiometer and loses it's value after restarting the controller. Saving the value into the FLASH use the **Save Register**.

Bit 11:0 **CURRENT_LIMIT [11:0]**: Regenerative current limit register value

Max value is 4095

Min value is 0

*Note: for the corresponding curret value check the **Register Value Range** table.*

Acceleration Limit Register:

Type: Write / Read

Write command: 0x44

Read command: 0x04

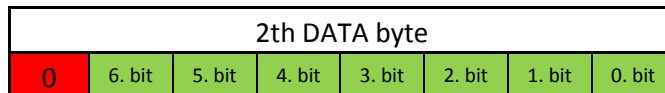
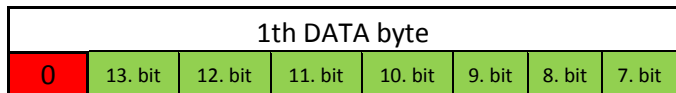

Acceleration Limit Register sets the time how fast the output follows the speed register's value under raising condition. With default settings it is equal to the controller's acceleration (RAMP) potentiometer's setting. Writing into this register overwrites the value of the potentiometer and holds the value as long as the potentiometer has the same value as it was before the overwrite. When the potentiometer changes (turning up/down the potentiometer) the controller going to overwrite the register with the value of the potentiometer.

It is possible to lock the register value (potentiometer can't overwrite the register) for this feature use the **Lock Variable Register**.

The register set and cleared by UART write or the potentiometer and loses it's value after restarting the controller. Saving the value into the FLASH use the **Save Register**.

Bit 11:0 **CURRENT_LIMIT [11:0]**: Acceleration limit register value

Max value is 4095

Min value is 0

*Note: for the corresponding time value check the **Register Value Range** table.*

Deceleration limit register:

Type: Write / Read

Write command: 0x45

Read command: 0x05

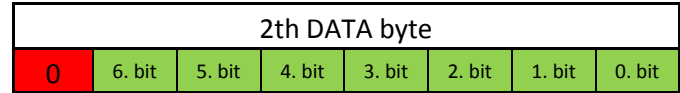
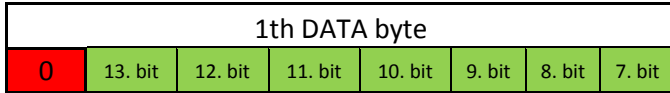

Deceleration Limit Register sets the time how fast the output follows the speed register's value under falling condition. With default settings it is disabled in the controller.

Saving the value into the FLASH use the **Save Register**.

Bit 11:0 **DECELERATION_LIMIT [11:0]**: Deceleration limit register value

Max value is 4095

Min value is 0

*Note: for the corresponding time value check the **Register Value Range** table. The minimum value is 1.*

Turning off minimum voltage register:

Type: Write / Read

Write command: 0x46

Read command: 0x06

1th DATA byte							
0	13. bit	12. bit	11. bit	10. bit	9. bit	8. bit	7. bit

2th DATA byte							
0	6. bit	5. bit	4. bit	3. bit	2. bit	1. bit	0. bit

Turning Off Minimum voltage register sets the voltage level where the controller will shut down if the supply voltage is lower than the register value. With default settings it is disabled in the controller. Writing and locking this register activates the function. When the controller shutting down because of the low supply voltage level the corresponding status register gets an update about the low supply voltage.

Saving the value into the FLASH use the **Save Register**.

Bit 11:0 **TURN_OFF_MIN [11:0]:**

Max value is 4095

Min value is 0

*Note: for the corresponding voltage level check the **Register Value Range** table.*

Turning on minimum voltage register:

Type: Write / Read

Write command: 0x47

Read command: 0x07

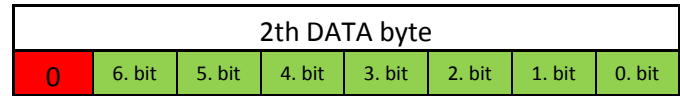
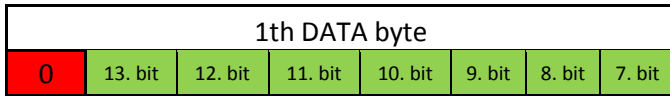

Turning On Minimum voltage register sets the voltage level where the controller will turn back from low supply status if the supply voltage is higher than the register value. With default settings it is disabled in the controller. Writing and locking this register activates the function.

Saving the value into the FLASH use the **Save Register**.

Bit 11:0 **TURN_ON_MIN [11:0]:**

Max value is 4095

Min value is 0

*Note: for the corresponding voltage level check the **Register Value Range** table.*

Turning on maximum voltage register:

Type: Write / Read

Write command: 0x48

Read command: 0x08

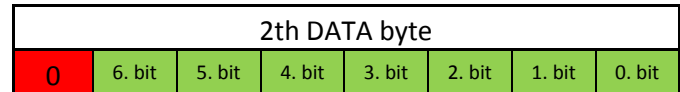
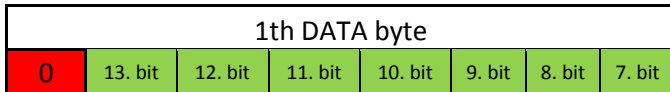

Turning On maximum voltage register sets the voltage level where the controller will turn back from high supply voltage status if the supply voltage is lower than the register value. With default settings it is disabled in the controller. Writing and locking this register activates the function.

Saving the value into the FLASH use the **Save Register**.

Bit 11:0 **TURN_ON_MAX [11:0]:**

Max value is 4095

Min value is 0

*Note: for the corresponding voltage level check the **Register Value Range** table.*

Turning off maximum voltage register:

Type: Write / Read

Write command: 0x49

Read command: 0x09

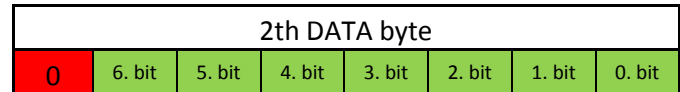
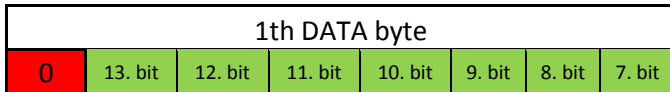

Turning Off Maximum voltage register sets the voltage level where the controller will shut down if the supply voltage is higher than the register value. With default settings it is disabled in the controller. The internal maximum voltage settings may rewrite this register. Writing and locking this register activates the function. When the controller shutting down because of the high supply voltage level the corresponding status register gets an update about the high supply voltage.

Saving the value into the FLASH use the **Save Register**.

Bit 11:0 **TURN_OFF_MAX [11:0]:**

Max value is 4095

Min value is 0

*Note: for the corresponding voltage level check the **Register Value Range** table.*

Heatsink Temperature Register:

Type: Read
Read Command: 0x0A

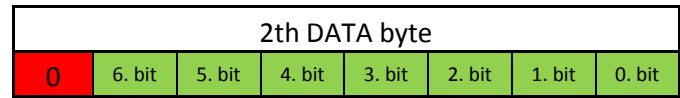
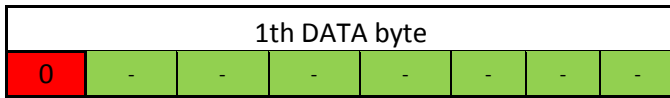

This register holds the actual heatsink temperature value in °C.

Bit 11:0 **HEATSINK TEMPERATURE [11:0]:**
Max value is 80
Min value is 10

Note: for the corresponding temperature value check the **Register Value Range** table.

Mainboard Temperature Register:

Type: Read
Read Command: 0x0B

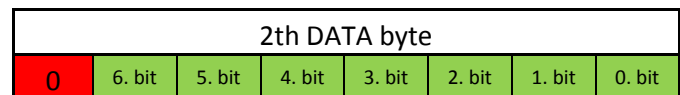
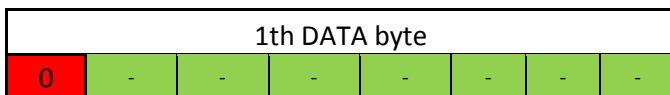

This register holds the actual mainboard temperature value in °C.

Bit 11:0 **MAINBOARD TEMPERATURE [11:0]:**
Max value is 4095
Min value is 0

Note: for the corresponding temperature value check the **Register Value Range** table.

Supply Voltage Register:

Type: Read

Read Command: 0x10

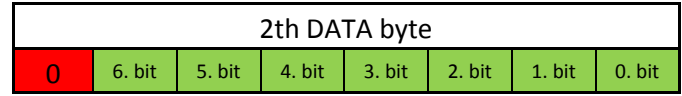
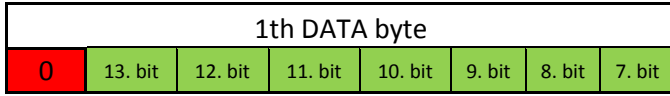

This register holds the actual supply voltage value.

Bit 11:0 **SUPPLY VOLTAGE [11:0]:**

Max value is 4095

Min value is 0

*Note: for the corresponding voltage value check the **Register Value Range** table.*

Speed ADC Input Register:

Type: Read

Read Command: 0x11

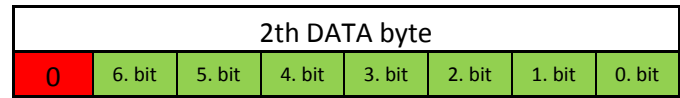
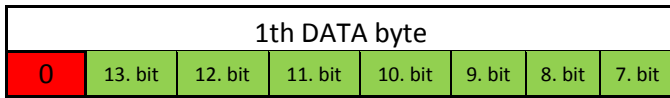

Controlling and locking the controller with UART Speed commands the Speed ADC input can serve other task like measuring a sensor or anything else.

Using the Speed ADC input for other task and not for the speed control function the Speed Register Lock bit must be enabled.

Bit 11:0 **SPEED ADC INPUT [11:0]:**

Max value is 4095

Min value is 0

*Note: for the corresponding voltage value check the **Register Value Range** table.*

Load Current Register:

Type: Read

Read Command: 0x12

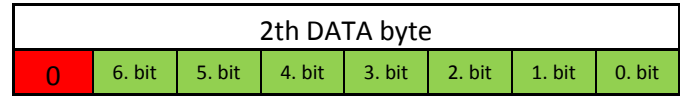
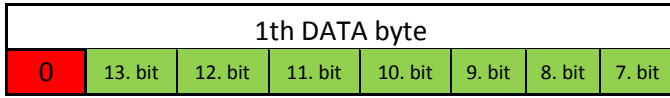

This register holds the actual output load current.

Bit 11:0 **LOAD CURRENT [11:0]:**

Max value is 4095

Min value is 0

*Note: for the corresponding current value check the **Register Value Range** table.*

Input Frequency Period Register:

Type: Read

Read Command: 0x14

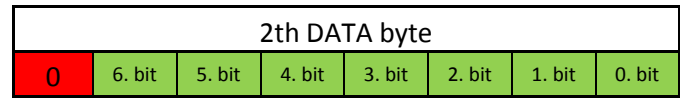
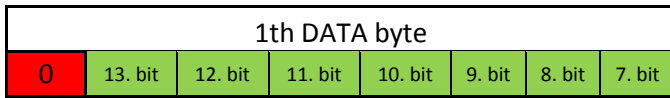

The controller PWM/brake input can be used for measuring pulses and other purposes. Like hall sensors encoders etc. Input Frequency Register holds the period's of the measured signal.

Bit 13:0 **INPUT FREQUENCY PERIOD REGISTER [13:0]:**

Max value is 16383

Min value is 0

*Note: for the corresponding value check the **Register Value Range** table.*

Input Pulse Width Register:

Type: Read

Read Command: 0x15

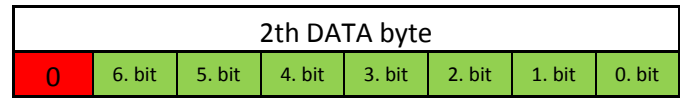
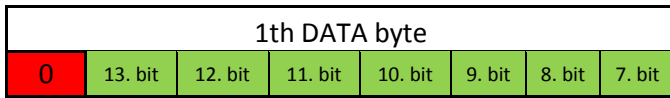

The controller PWM/brake input can be used for measuring pulses and other purposes. Like hall sensors encoders etc. Input Pulse Width Register holds the width of the captured pulse of the measured signal.

Bit 13:0 **INPUT PULSE WIDTH REGISTER [13:0]:**

Max value is 16383

Min value is 0

*Note: for the corresponding time value check the **Register Value Range** table.*

I x R compensation register:

Type: Write / Read

Write Command: 0x60

Read Command: 0x20

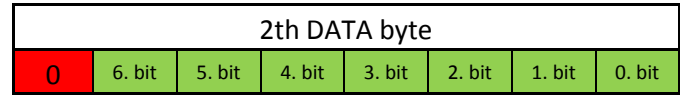
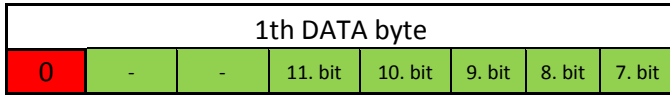

I x R compensation value can be used for gain the output voltage when the motor internal resistance causing voltage drop and RPM drop. This value will be multiplied with the load current and added to the output voltage. Using the I X R compensation constant from the Register Value Range table you can calculate the needed value.

The [%/A] tell how much compensation is needed for running the motor at the same RPM under load.

Bit 13:0 I x R COMPENSATION REGISTER [13:0]:

Max value is 16383

Min value is 0

*Note: for the corresponding value check the **Register Value Range** table.*

Top Speed register:

Type: Write / Read

Write Command: 0x61

Read Command: 0x21

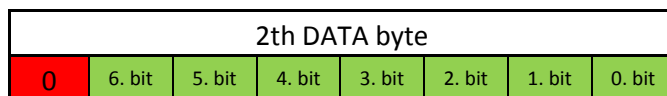
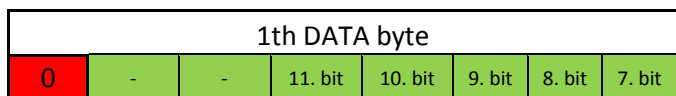

Top Speed value can be used for making a reference voltage for the speed input or speed register. This can make a supply compensation when the supply voltage is changes or you can limit the maximum output output voltage / motor RPM and does not matter if the speed potentiometer would set higher output voltage the Top Speed will overwrite this value.

For the calculation use the given top speed constant from the **Register Value Range** table.

Giving and example: If the constant for the given controller is 18,51mV than if you need a maximum output voltage of 20V than calculate like this: $Top\ Speed = 20V / 0.01805V = 1080$.

So writing the 1080 in the top speed register you can set maximum 20V output voltage with the potentiometer. If your supply voltag changes between higher ranges for example 25-50V your output voltage remains the same 20V or less depending on your speed potentiometer's setting.

With TOP Speed settings you can have supply compensation fixing the speed variation with different supply voltages.

Turning on the supply compesation you need to turn on the **Top Speed /Supply compensation** bit in the **Configuration_bits_2** register.

Giving 0 or near 0 value of this register can cause 0V output voltage.

Bit 13:0 **TOP SPEED REGISTER [11:0]:**

Max value is 4095

Min value is 0

*Note: for the corresponding value check the **Register Value Range** table.*

Potentiometer min. register:

Type: Write / Read

Write Command: 0x62

Read Command: 0x22

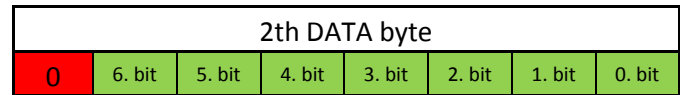
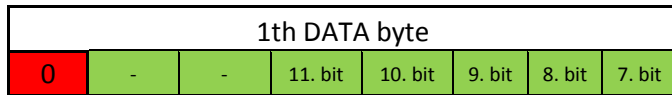

With Potentiometer min and max you can define your voltage levels on the speed input what you need for the given 0% output voltage and the given 100% output voltage.

For the calculation use the given potentiometermin/max constant from the **Register Value Range** table.

Giving and example: If the constant for the given controller is 1,184mV than if you need the 0% output starting form the speed input=1V

$$\text{Potentiometer min register} = 1V/1,184mV = \underline{844}$$

Using this function you need to save the potentiometer min/max registers in the flash memory using the **Save register** and restart the controller with SW mode setting: 1:OFF 2:OFF.

Bit 13:0 **Potentiometer Min register [11:0]:**

Max value is 4095

Min value is 0

*Note: for the corresponding value check the **Register Value Range** table.*

Potentiometer max. register:

Type: Write / Read

Write Command: 0x63

Read Command: 0x23

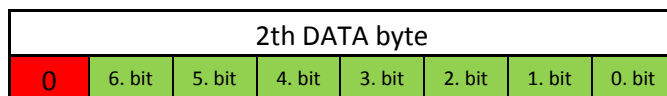
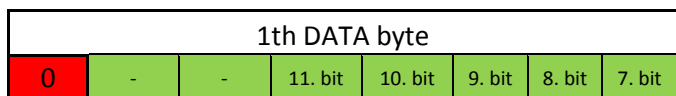

With Potentiometer min and max you can define your voltage levels on the speed input what you need for the given 0% output voltage and the given 100% output voltage.

For the calculation use the given potentiometermin/max constant from the **Register Value Range** table.

Giving and example: If the constant for the given controller is 1,184mV than if you need the 100% output ending at the speed input=3,5V

$$\text{Potentiometer maxregister} = 3,5V / 1,184mV = \underline{2956}$$

Using this function you need to save the potentiometer min/max registers in the flash memory using the **Save register** and restart the controller with SW mode setting: 1:OFF 2:OFF.

Bit 13:0 **Potentiometer Max register [11:0]:**

Max value is 4095

Min value is 0

*Note: for the corresponding value check the **Register Value Range** table.*

Status Register:

Type: Read
Read Command: 0x30

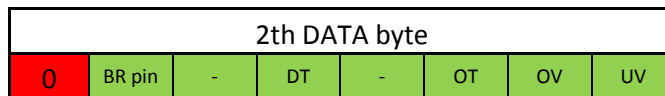
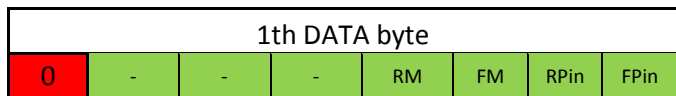

- Bit 10 **RM:** Reverse mode:
0: Stop (controller will stop if both Forward mode and Reverse mode is 0)
1: Controller in reverse mode.
- Bit 9 **FM:** Forward mode:
0: Stop (controller will stop if both Forward mode and Reverse mode is 0)
1: Controller in forward mode.
- Bit 8 **BR Pin:** Brake input pin state bit.
0: Brake pin is "Low"
1: Brake pin is "High"
Note: reading this you need to be not in PWM mode.
- Bit 7 **BR Pin:** Brake input pin state bit.
0: Brake pin is "Low"
1: Brake pin is "High"
Note: reading this you need to be not in PWM mode.
- Bit 6 **BR Pin:** Brake input pin state bit.
0: Brake pin is "Low"
1: Brake pin is "High"
Note: reading this you need to be not in PWM mode.
- Bit 4 **DT:** Drive status bit:
0: Drive mode
1: Brake mode
- Bit 2 **OT:** Over temperature status bit.
0:
1: Supply voltage is lower than the Turn on minimum register value.
- Bit 1 **OV:** Over voltage status bit.
0:
1: Supply voltage is higher than the Turn off maximum register value.
- Bit 0 **UV:** Under voltage status bit.
0:
1: Supply voltage is lower than the Turn on minimum register value.

Lock Variables Register:

Type: Write / Read

Write Command: 0x71

Read Command: 0x31

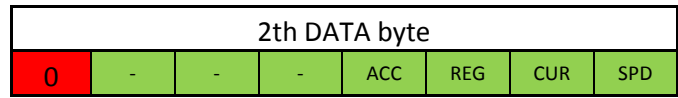
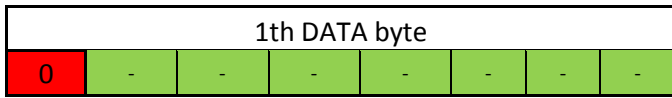

Locking any register means only USART update can overwrite it's value. The on board potentiometers will be disabled as long as the associated bit is "1".

This is good if you want to deny the possibility to change the value of the registers on board. Other advantage if you want to use the Speed input for other purposes than you need to lock the SPD register otherwise the value of the speed input will be used for setting the output voltage.

Bit 3 **ACC:** Writing "1" locks the Acceleration Limit Register.

Bit 2 **REG** Writing "1" locks the Regeneration Limit Register.

Bit 1 **CUR:** Writing "1" locks the Current Limit Register.

Bit 0 **SPD:** Writing "1" locks the Speed Register.

Note: This register going to lose it's content after restarting the controller.

Save bits 1 register:

Type: Write / Read

Write Command: 0x72

Read Command: 0x32



These bits are set all the registers you want to save into the flash memory. Writing into this register only designates the register to be saved. The actual saving command will be done only with writing the Save_bits_2 register. When a memory saving occurs the data will be reloaded from the memory after every restart. Saving a register data automatically locks the particular register and only USART update can rewrite it.

- Bit 13 **CONF2:** Configuration 2 Register.
0: no saving
1: Save the given register into flash memory.

- Bit 12 **CONF1:** Configuration 1 Register.
Refer to the Bit 13 CONF2 description.

- Bit 11 **ADDR:** Configuration 2 Register.
Refer to the Bit 13 CONF2 description.

- Bit 9 **OFF_H:** Save turning off maximum value.
Refer to the Bit 13 CONF2 description.

- Bit 8 **ON_H:** Save turning on maximum value.
Refer to the Bit 13 CONF2 description.

- Bit 7 **ON_L:** Save turning off minimum value.
Refer to the Bit 13 CONF2 description.

- Bit 6 **OFF_L:** Save turning off low value.
Refer to the Bit 13 CONF2 description.

- Bit 5 **DEC:** Save deceleration value.
Refer to the Bit 13 CONF2 description.

- Bit 4 **ACC:** Save acceleration value.
Refer to the Bit 13 CONF2 description.

- Bit 3 **REG:** Save regenerative current limit value.
Refer to the Bit 13 CONF2 description.

- Bit 2 **CUR:** Save current limit value.
Refer to the Bit 13 CONF2 description.

- Bit 0 **SPD:** Save speed value.
Refer to the Bit 13 CONF2 description.

Save bits 2 register:

Type: Write / Read

Write Command: 0x72

Read Command: 0x33



These bits are set all the registers you want to save into the flash memory. Writing into this register designates the register to be saved and initiates the saving command. When a memory saving occurs the data will be reloaded from the memory after every restart. Saving a register data automatically locks the particular register and only USART update can rewrite it.

IMPORTANT: Writing into this register as a repeated operation is not recommended. **The FLASH memory rewritable life cycle is limited about 10.000 saving operation! Under the save operation the PWM controller stops and no other operation can be used!**

- Bit 4 **P_MAX:** Potentiometer Maximum
0: no saving
1: Save the given register into flash memory.

- Bit 3 **P_MIN:** Potentiometer Minimum
Refer to the Bit 8 OFH description.

- Bit 2 **TOP_S:** Top Speed/Supply compensation
Refer to the Bit 8 OFH description.

- Bit 1 **IR_COM:** I x R compensation
Refer to the Bit 8 OFH description.

- Bit 0 **C_CAL:** Current calibration
Refer to the Bit 8 OFH description.

Configuration bits 1 register:

Type: Write / Read

Write Command: 0x74

Read Command: 0x34

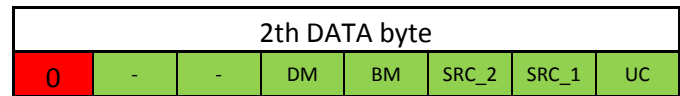
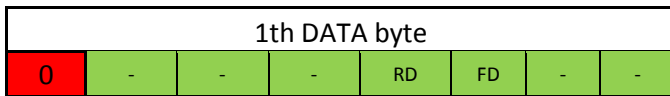

Bit 10 **RD:** Reverse Direction:

0: Stop

1: Set reverse direction.

*Note: when you are changing direction keep the **UC** bit high and **SRC** bits in the desired mode.*

Bit 9 **FD:** Forward Direrection:

0: Stop

1: Set forward direction.

*Note: when you are changing direction keep the **UC** bit high and **SRC** bits in the desired mode.*

Bit 4 **DM:** Selecting operation mode

This bit set and cleared by UART write and cleared by hardware after restart.

0: Drive mode.

1: Brake mode or free running mode depending on **BM** bit.

Bit 3 **BM:** Braking mode

This bit set and cleared by UART write and cleared by hardware after restart.

0: Manual brake (free running mode)

1: Auto brake (automatic regeneration)

Note: Manual brake let the motor spinning free after turning down the speed or sending 0 speed command. Auto brake start automatic current regeneration into the supply when the motor internal voltage is higher than the speed.

Bit 2:1 **SRC[1:0]:** Speed reset controll

This bit set and cleared by UART write and cleared by hardware after restart.

00: No speed reset after no UART speed update.

01: Speed reset after 50msec without new UART speed update.

10: Speed reset after 500msec without new UART speed update.

11: Speed reset after 2800msec without new UART speed update.

Bit 0 **UC:** UART controll bit

This bit set and cleared by UART write and cleared by hardware after restart.

0: Disable the configuration bits

1: Enable the configuration bits

Configuration bits 2 register:

Type: Write / Read
 Write Command: 0x75
 Read Command: 0x35

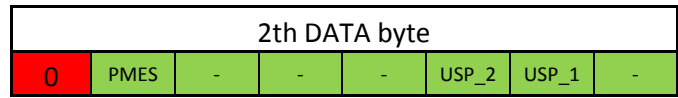
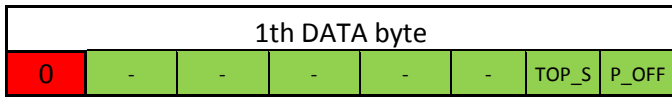

Note: writing 1 clears the given bit writing 0 makes no changes.

- Bit 8 **TOP_S:** Top Speed/Supply compensation enable bit.
 0: Disable
 1: Enable

- Bit 7 **P_OFF:** Pin terminals OFF .
This bit is used to disable the Brake function of the PWM/Brake input and using as a logical input.
 0: Enable
 1: Disable

- Bit 6 **BMC:** Pulse Measurement resolution
Resolution on the PWM/brake input
 0:
 1:

- Bit 2:1 **USP [1:0]:** USART communication speed.
 Default speed is 19200 Baud/sec
These bits set the UART baud/sec rate.
 00: 19200 Baud/sec
 01:
 10:
 11:

USART Address Register:

Type: Write
Write command: 0x7C

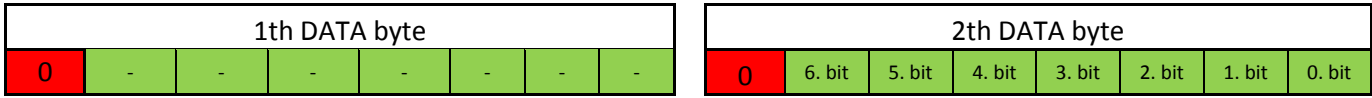

USART Address bits is a unique 7bit address which marks the given controller. It allows to connect several controllers or even other USART devices to connect to the same RX TX channel. The default USART address is 0x00. If you want to control two or more controllers through the USART you have to change the address first one by one. After this it is possible to connect more devices to the same USART channel. USART Address will be saved into the FLASH memory and reloaded from the memory after every restart.

The controllers send out their unique USART address right after the system start. This helps to recover and recognize a forgotten address.

Bit 6:0 **USART ADDRESS [6:0]:**
Max value is 0x7F
Default value: 0x00

Current measurement calibration register:

Type: Write
Write command: 0x7D



Motor controller boards may have current measurement error 1-15% depending on the model. Calibrating and saving the current measurement register solve the error problem and will use the value for the measurement correction.

For the calibration you need follow the steps:

1. Set maximum speed potentiometer input
2. Turn down the current limit
3. Place a pure inductive load to the output. You can use large inductors or a stalled DC- motor.
4. Place a current meter or digital clamp meter measuring the motor current.
5. Turn on the supply
6. Slowly turn up the current limit potentiometer
7. Regarding the controller and your load current capabilities turn up the current to a high enough level. For example with a 100A motor controller 30A is enough.
8. When you read the exact current on your own current meter you need to send the equivalent value into the **Current Measurement Calibration** register. Calculating the value use the constant in the **Register Value Range** table.
9. Save the register with the **Saving bits** register.

Note: If the deviation between the sent value and the internal current measurement is larger than +/-20% than the controller will ignore the command.

Example: If you Set 30A load current and your constant is 0,244A then the register value will be: $30A/0,244A = 123$

Software version register:

Type: Read
 Read command: 0x3E

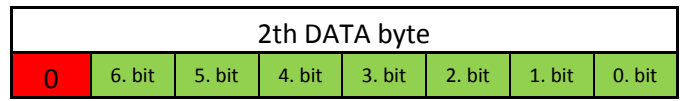
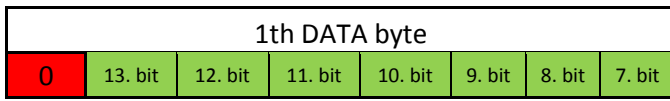

Hardware version register:

Type: Read
 Read command: 0x3F

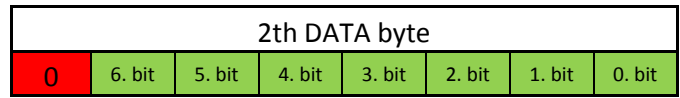
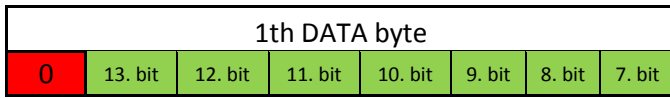

Examples:

Example 1: Calling 0x00 address device and writing DATA_to send: 0x05C5 value into the Speed register:

Sent bytes:

0x80	0x40	0x0B	0x45	0x10
------	------	------	------	------

C conversion code before sending out the bytes:

```
ADDRESS=UNIT_ADDRESS | 0x80;
COMMAND= for this check the write commands in the register table
DATA_1th= (DATA_to_send>>7) & 0x7F;
DATA_2th=DATA_to_send & 0x7F;
CRC=( COMMAND + DATA_1th + DATA_2th) & 0x7F;
```

Example 2: Calling 0x00 address device and locking Speed variable:

Setting the speed you should read the **configuration_bits_1 SRC** bit it makes timeout for the speed reset controll if you want to add safety shut down when the controll signal stops or you are using wireles communication it is useful to reset the speed if there is no new update.

Sent bytes:

0x80	0x71	0x00	0x01	0x72
------	------	------	------	------

C conversion code before sending out the bytes:

Refer to the Example 1.

If you are just starting the controller you need to set forward or reverse direction with the **configuration_bits_1** register. You can do it like this:

You probably want to overwrite the direction switch inputs so you need to turn on **UC** bit as well. And set FR direction bit.

Sent bytes:

0x80	0x74	0x04	0x01	0x79
------	------	------	------	------

Example 3: Calling 0x02 address device to change the regenerative brkaking mode to "auto regen" from "free running mode"and initiating regenerative braking with 0x062C current:

For this you need to execute 2 write comands. The first set the regenerative current limit.

Sent bytes:

0x82	0x43	0x0C	0x2C	0x7B
------	------	------	------	------

C conversion code before sending out the bytes:

Refer to the Example 1.

Second to set the Configuration bit:.

Sent bytes:

0x82	0x74	0x00	0x19	0x0D
------	------	------	------	------

C conversion code before sending out the bytes:

*Refer to the Example 1. and **Set Configuration bits register.***

Example 4: Calling 0x00 address device to read the load_current_register:

Sent bytes:

0x80	0x12
------	------

 (read command)

Received bytes from the controller:

0x13	0x36	0x0D
------	------	------

C conversion code for the received bytes:

CRC check:

```
if(((received_byte_1th + received_byte_2th + Read_command) & 0x7F) == received_byte_3th)
{
    load_current_register = (received_byte_1th << 7) | (received_byte_2th & 0x7F);
}
```