

TYPE: "x"

Pin	in	out
1	in	
2	out	Spindle PWM
3	out	Spindle CCW
4	out	Spindle ON
5	out	X Step
6	out	X Direction
7	out	Z Step
8	out	Z Direction
9	out	Drive Enable
10	in	Spindle Phase A
11	in	Spindle Phase B
12	in	Spindle Index
13	in	Both Limit + Home X
14	in	Both Limit + Home Z
15	in	Probe
16	in	eStop in
17	in	

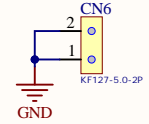
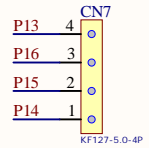
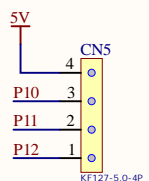
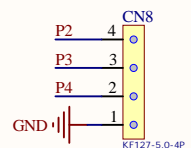
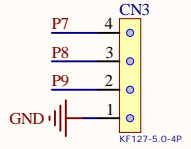
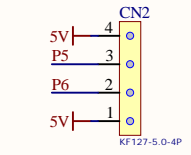
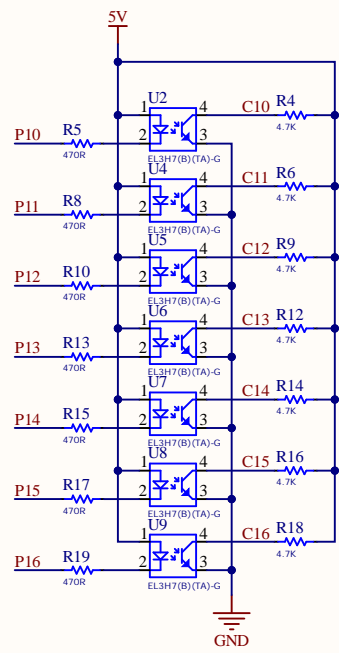

Title		
Size	Number	Revision
A4		
Date:	11/17/2023	Sheet of
File:	C:\Workstation\...\LinuxCNCboard.SchDoc	Drawn By: