

Incomplete draft  
 2023-08-11

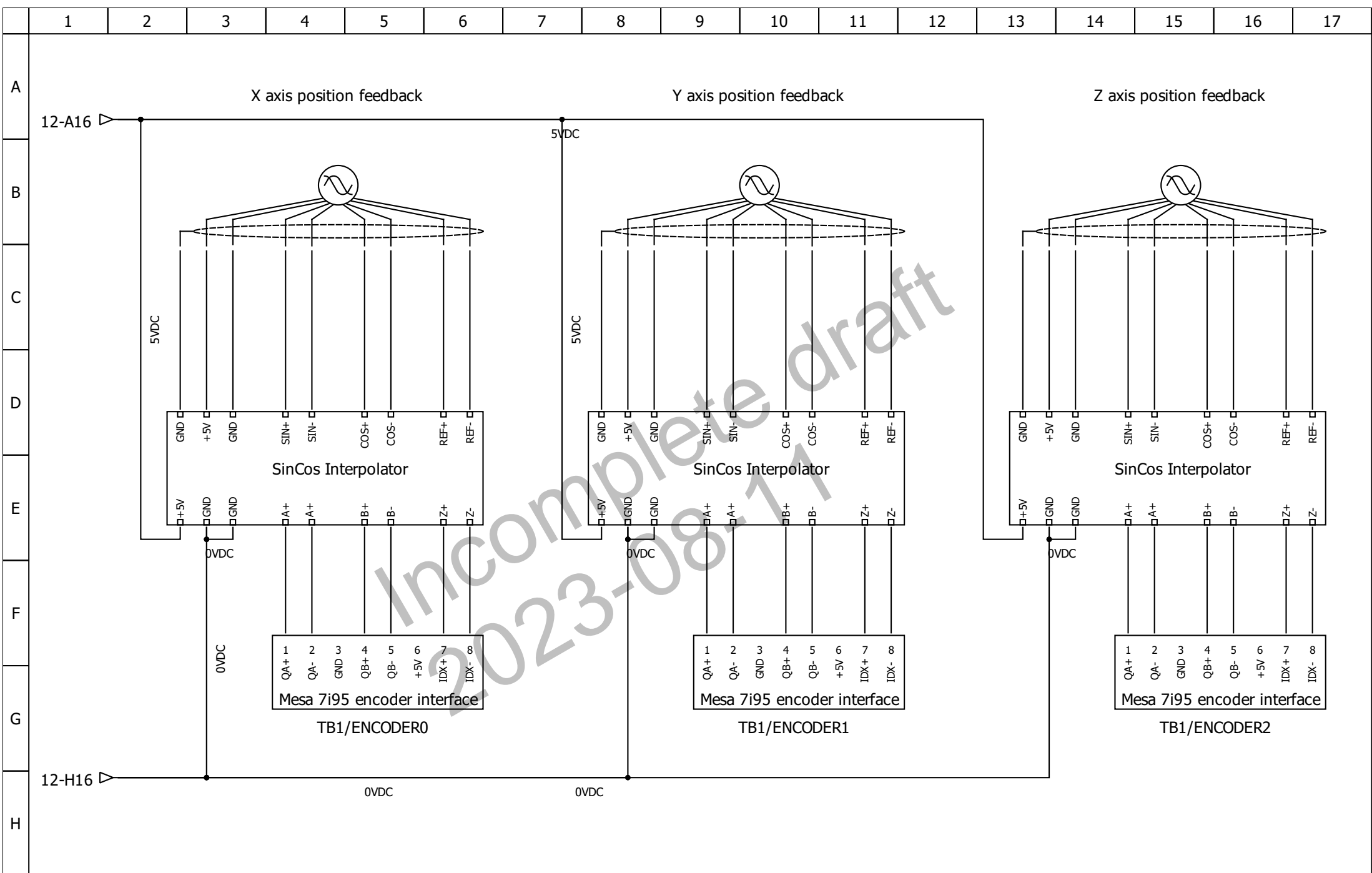

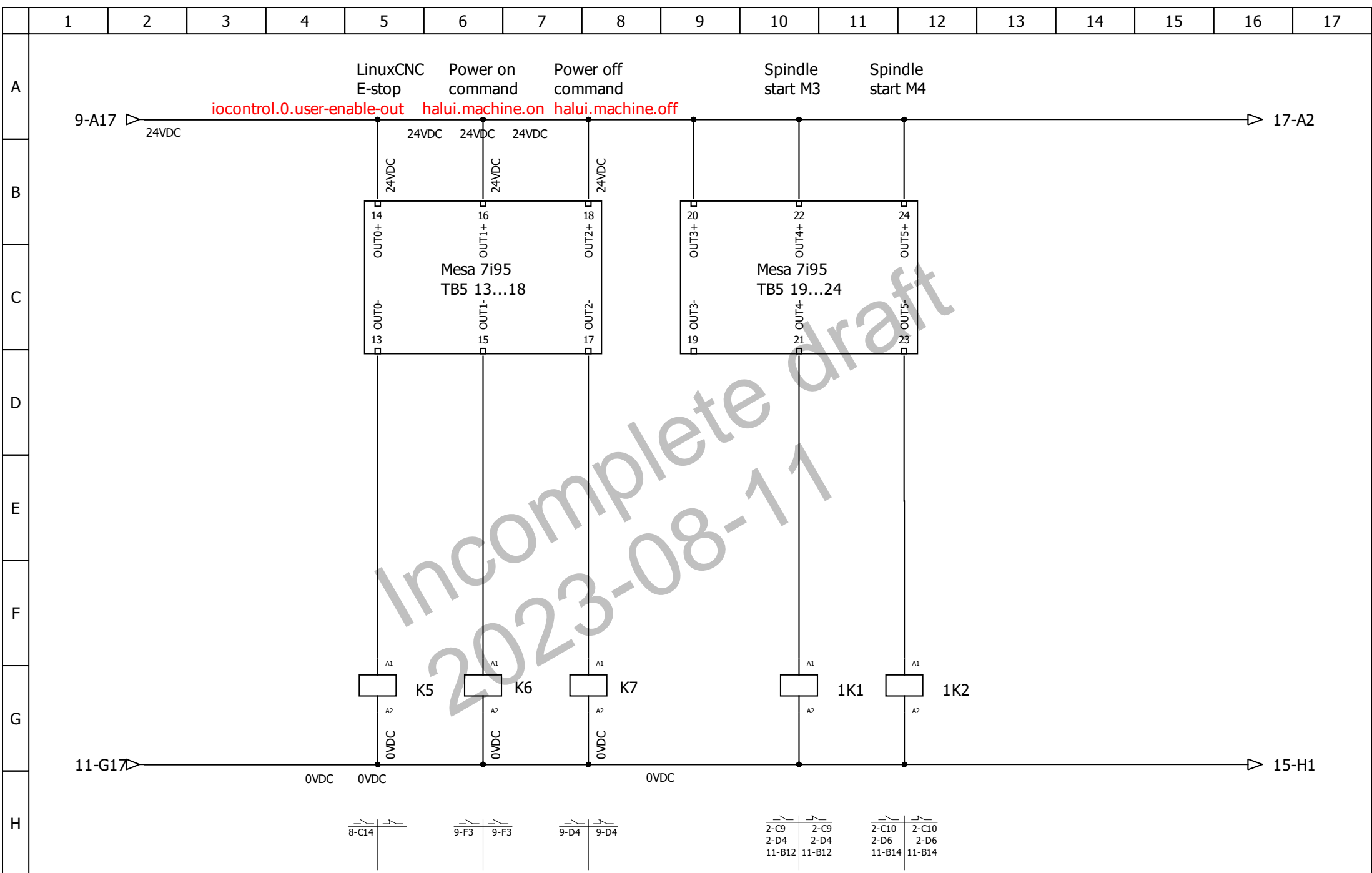

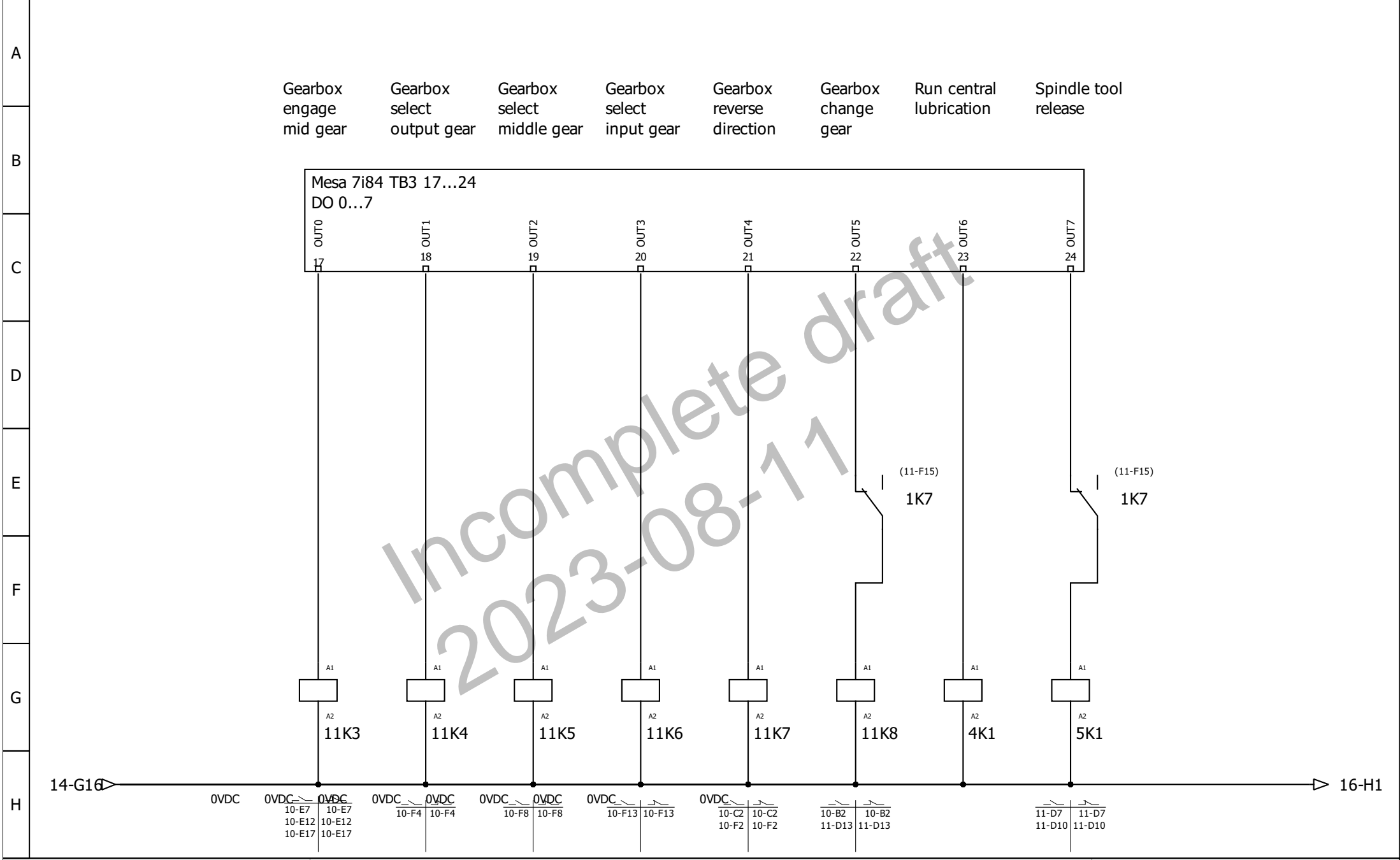

A

Flood coolant      Mist coolant

B

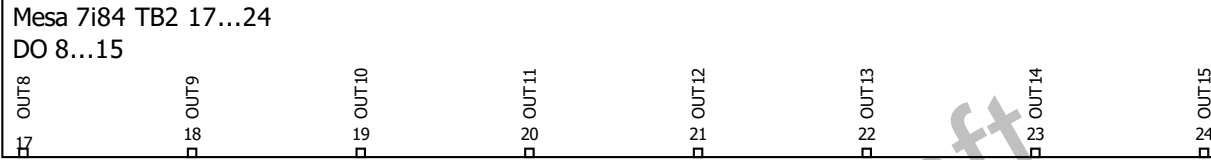

C

D

E

F

G

H

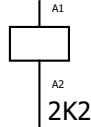
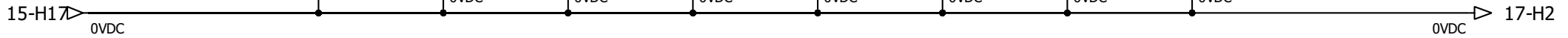

2K2

Incomplete draft  
2023-08-11



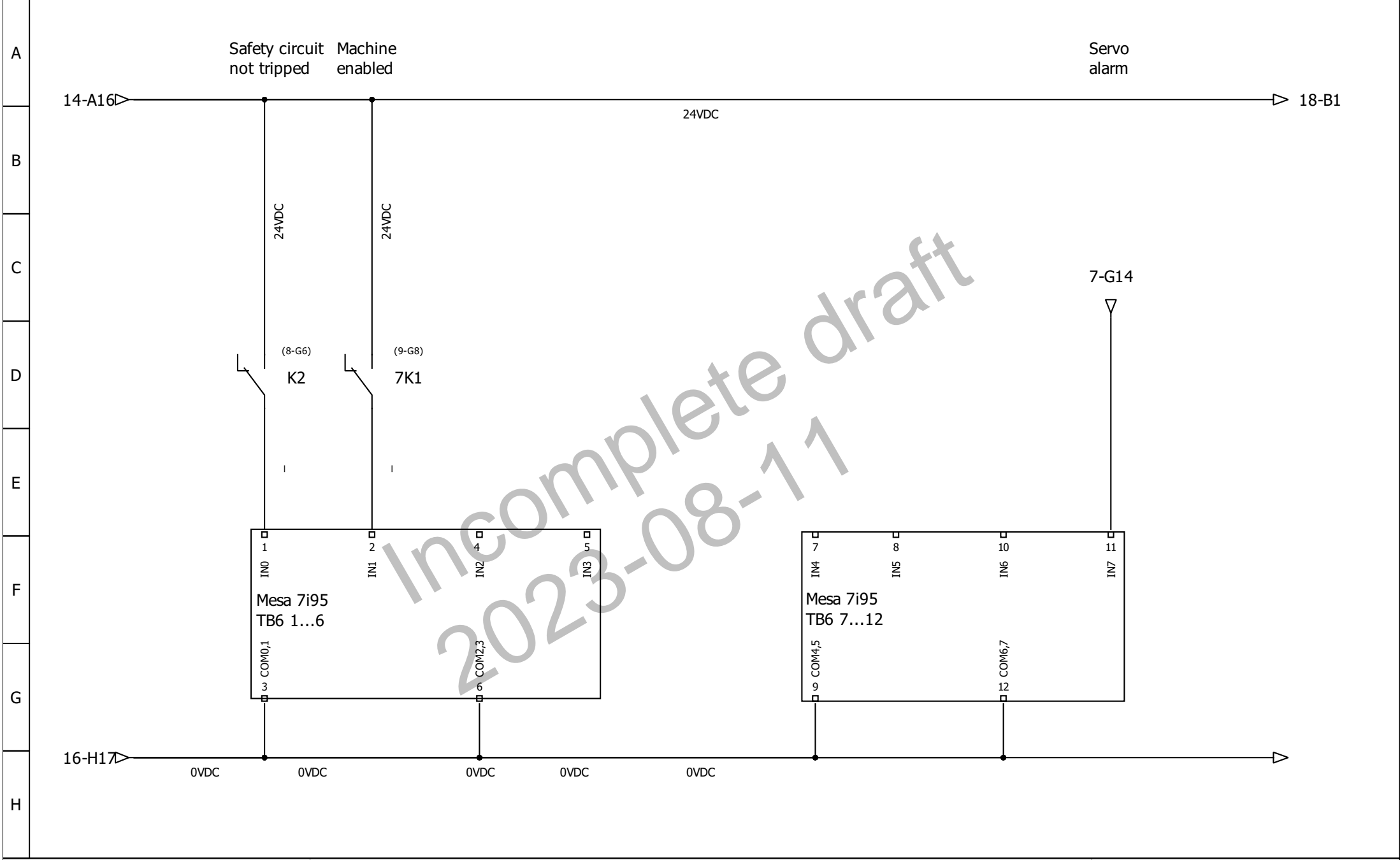

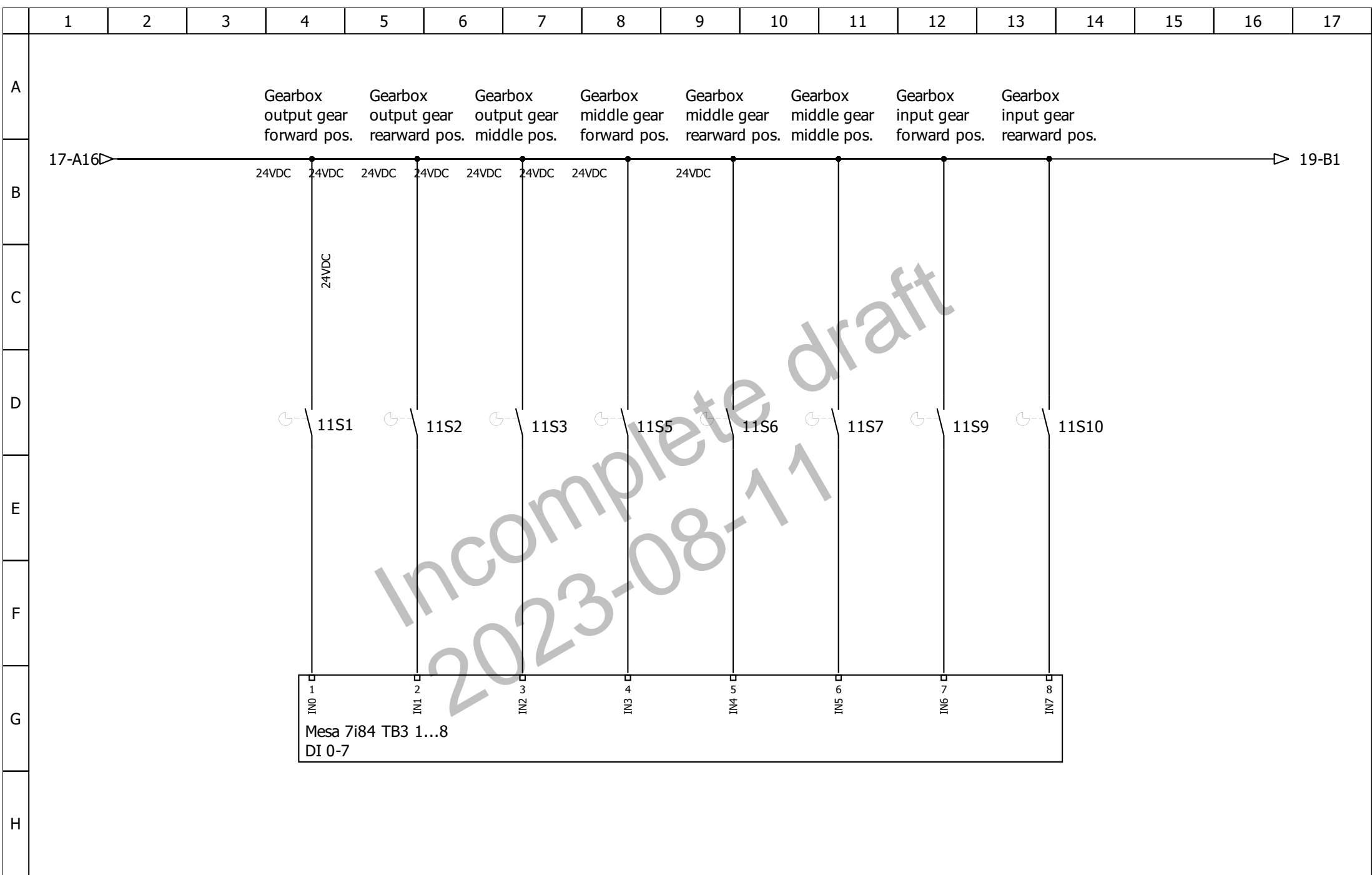

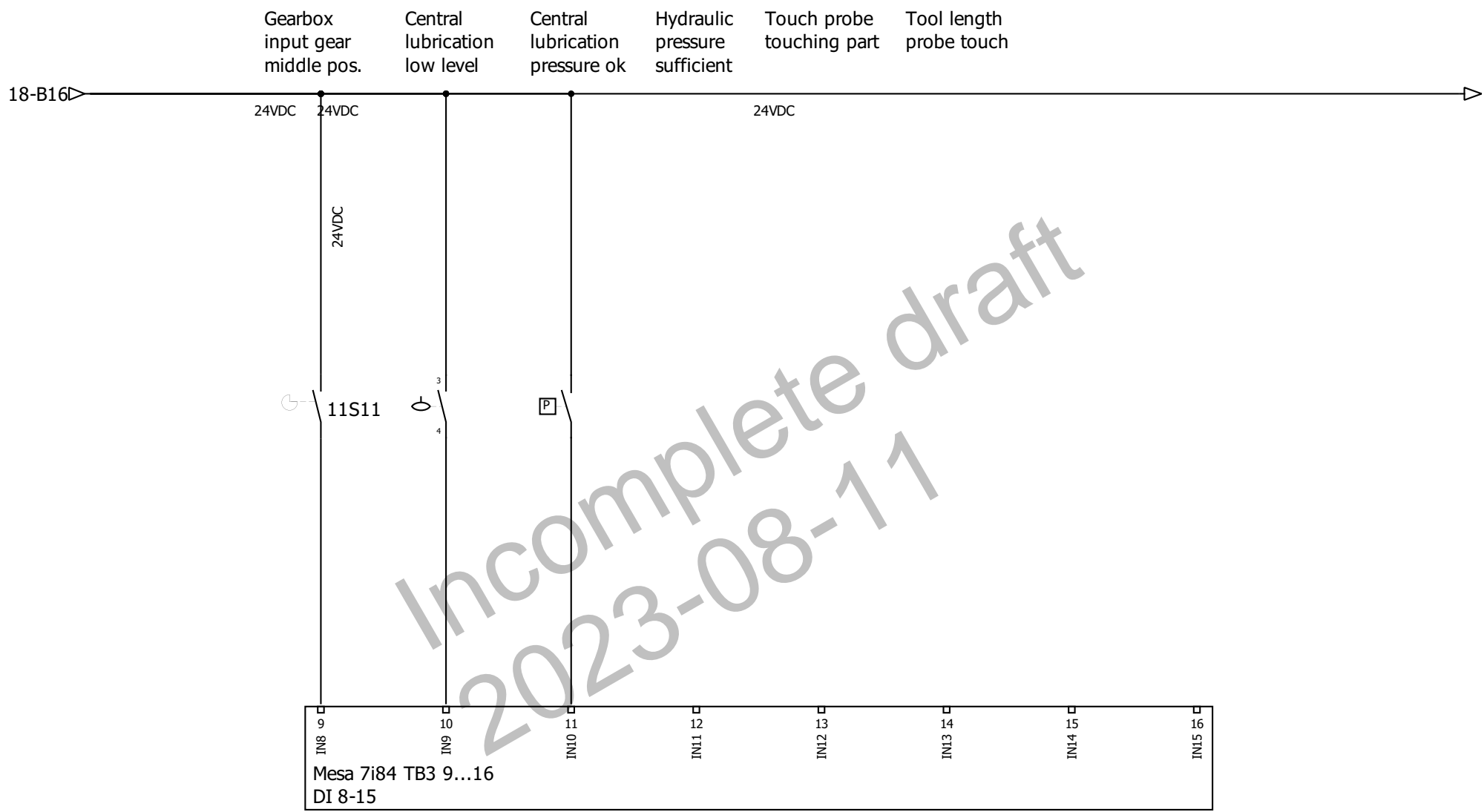

Incomplete draft  
2023-08-11

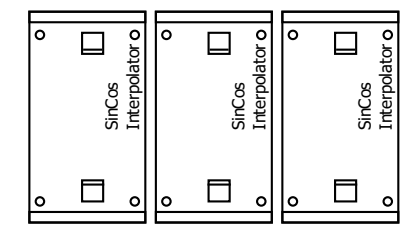
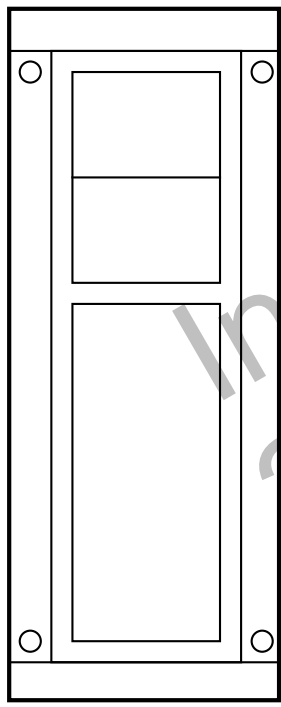
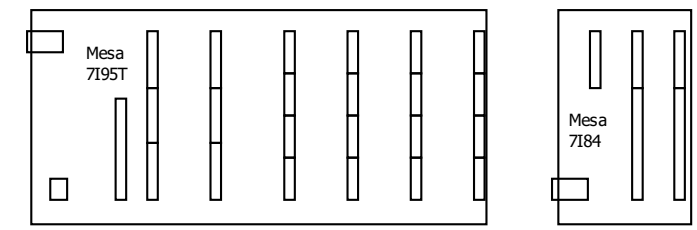
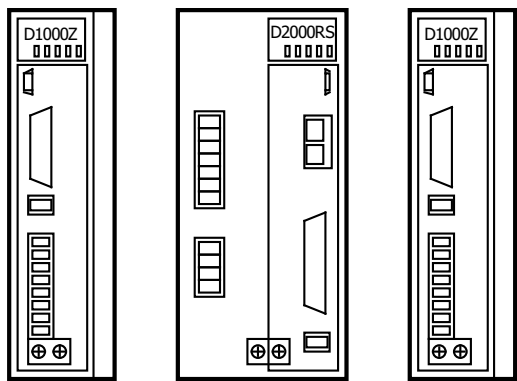

Incomplete draft  
2023-08-11